

## EURO / PCX LARGE HOUSING:

8 x Screws  
M3 x 5mm

4 x Pillars  
M3 x 8mm

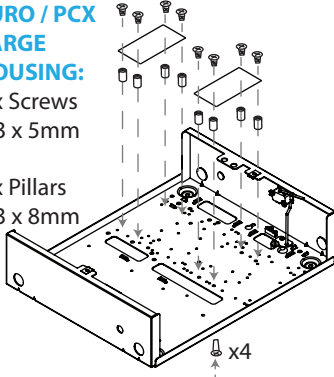

## EURO / PCX SMALL HOUSING:

4 x Screws  
M3 x 5mm

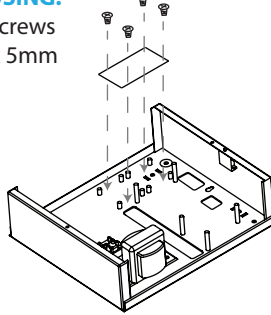

## ENFORCER HOUSING:

**IMPORTANT NOTE:** When connecting a DIGI-LAN to Enforcer & HomeControl+ panels you **MUST NOT** connect the power cable. **ONLY THE DATA CABLE** is required.

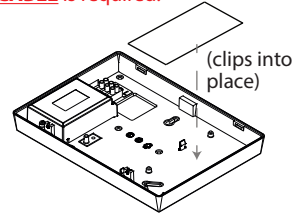

## The Printed Circuit Board (PCB)

### Operation LED

This LED blinks when the board has power.

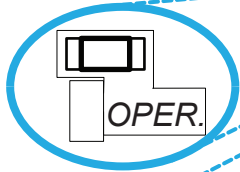

### Ethernet LEDs

Standard LAN/Ethernet cable 'Link' and 'Activity' LEDs indicate network activity.

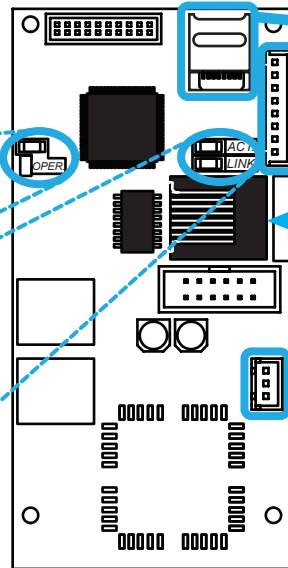

**Micro SD slot**  
(for future use)

**Modem Data Connection**  
(see wiring diagrams on the other side of this leaflet).

**LAN/Ethernet Port**

**12V DC Connection**

DO NOT USE for Enforcer & HomeControl+ Control panels (See wiring diagrams on the other side of this leaflet).

## Introduction / Setup Info

The DIGI-LAN modem is used to connect the panel via IP, and network using **TCP/IP**; this modem can be used when GPRS signal is not available in the area. The DIGI-LAN modem can be connected directly to a router via the existing Ethernet TCP/IP giving access to ADSL .

The modem can be set up in 2 distinct ways: - **DHCP (Auto assigned dynamic IP address)**  
- **Manual (IP address configured manually)**

The DHCP mode allows automatic assignment of the network details into the control panel. However, in some cases when there is a strong FIREWALL it will be necessary to assign the network details into the modem manually. NOTE: It is important in such cases to notice that if the firewall has all ports closed then the system administrator must open ports **TCP 25010** and **25000** to allow UDL and use of the HomeControl+ APP.

## Connection to EURO46 APP or PCX46 APP control panels

**NOTE 1:** When connecting the communications module, make sure that the control panel is fully powered down (mains and battery).

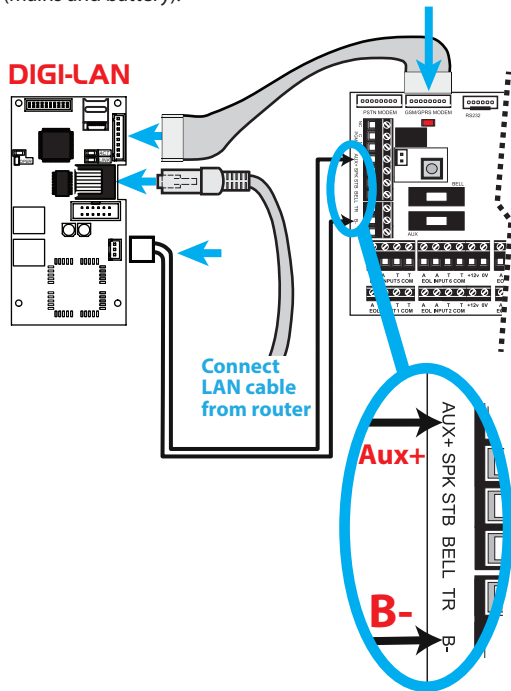

## Connection to Enforcer32-WE APP or HomeControl+ control panels

**NOTE 1:** When connecting the communications module, make sure that the control panel is fully powered down (mains and battery).

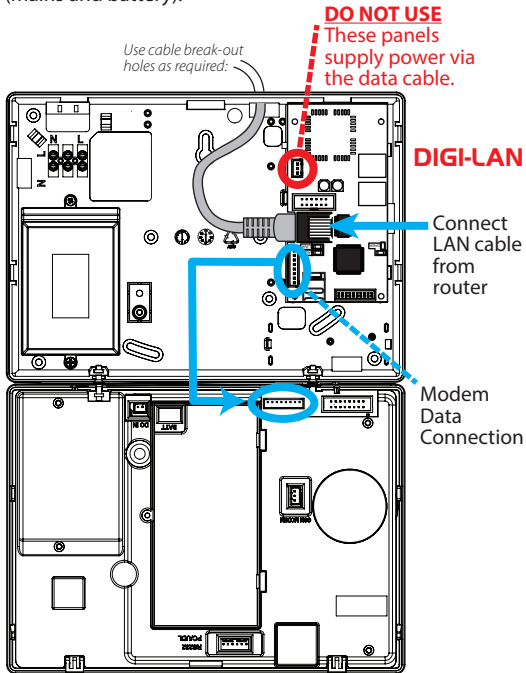

**IMPORTANT NOTE:** DIGI-LAN panel compatibility (**UK**) - HomeControl+ control panels **V2.0** and above, EURO-46 APP **V2.1** and above. (**EXPORT**): The DIGI-LAN can be used on the Enforcer32WE APP and PCX46 APP **V10.00** and above. Please see your control panel user, programming and installation manuals for further information.

### Technical Specification:

**12V DC Connection:** Power connection to control panel (PCX ONLY).

**Current draw:** 30mA

**Modem Data Connection:** Data connection to control panel PCB.

**Dimensions:** 109 x 56 x 14mm

**Formats:** Fast Format IP (UK Only), Contact ID IP, SIA IP, supports upload/download (via Insite UDL software).

### Troubleshooting:

- If using an ARC - check that the correct modem is setup within the 'COMMUNICATIONS' menu of your control panel.
- If experiencing connectivity problems - go into the 'DIAGNOSTICS' menu, and then the sub-menu within diagnostics called 'Communications' (not the separate 'COMMUNICATIONS' menu). Here you can view the IP address and see if the panel is polling the Pyronix Cloud or your ARC.
- If no LEDs are displayed, check the cables and power connection.
- If the DIGI-LAN is not recognised by the panel its ID will show "77777777", - power the panel down and back up again.

**Compliance:** Certified as SP5. For further information please see EN 50131-1: 2006 table 10

**Environmental Class (EC) II**  
EN 61000-6-3: 2007 +A1: 2011

EN 60950-1: 2006 +A11: 2009  
+A1: 2010 +A12: 2011 +A2: 2013

EN 50136-1: 2012  
EN 50136-2: 2013

ETSI EN 301 511: V9.0.2  
ETSI EN 301 489-1 V1.8.1/-7 V1.3.1  
CLC/ TS 50136-9: 2013



For electrical products sold within the European Community. At the end of the electrical products useful life, it should not be disposed of with household waste. Please recycle where facilities exist. Check with your Local Authority or retailer for recycling advice in your country.

This product is under general warranty for a period of 2 years - for full warranty details see:  
[www.pyronix.com/warranty](http://www.pyronix.com/warranty)

Pyronix Ltd, Secure House, Braithwell Way, Hellaby, Rotherham, South Yorkshire, S66 8QY.

E: [customer.support@pyronix.com](mailto:customer.support@pyronix.com). W: [www.pyronix.com](http://www.pyronix.com)